

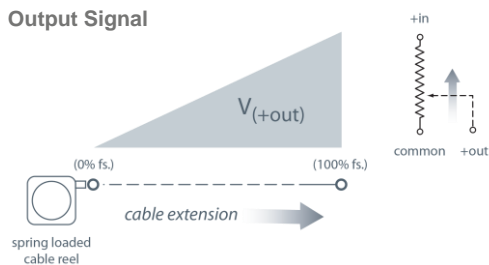

The PT8101, using a high cycle plastic-hybrid potentiometer, operates with any basic panel meter or programmable controller in factories and harsh environments requiring linear position measurements in ranges up to 60".

As a member of our innovative line of cable actuated sensors, the PT8101 installs in minutes by mounting its body to a fixed surface and attaching its cable to the movable object, works without perfect parallel alignment, and when its stainless-steel cable is retracted, it measures only 5". Cable actuated sensors are simple to install, exceptionally reliable and will fit into areas unsuited for rod-type measurement devices.

Output Signal



-- bridge circuit option available, see ordering information

PT8101

Cable Actuated Sensor Heavy Industrial • Voltage Divider

Absolute Linear Position to 60 inches (1524 mm)

Aluminum or Stainless Steel Enclosure Options

VLS Option to Prevent Free-Release Damage

IP68 • NEMA 6 Protection

General

Full Stroke Ranges	0-2 to 0-60 inches
Output Signal	voltage divider (potentiometer)
Accuracy	± 1.0% to ± 0.1% full stroke. (see ordering information)
Repeatability	± 0.02% full stroke
Resolution	essentially infinite
Measuring Cable	stainless steel or thermoplastic
Enclosure Material	powder-painted aluminum or stainless steel
Sensor	plastic-hybrid precision potentiometer
Potentiometer Cycle Life	see ordering information
Maximum Retraction Acceleration	see ordering information
Weight, Aluminum (Stainless Steel) Enclosure	3 lbs. (6 lbs.), max.

Electrical

Input Resistance	see ordering information
Power Rating, Watts	see ordering information
Recommended Maximum Input Voltage	see ordering information
Output Signal Change Over Full Stroke Range	see ordering information

Environmental

Enclosure	NEMA 4X/6, IP 67
Operating Temperature	-40° to 200°F (-40° to 90°C)
Vibration	up to 10 g to 2000 Hz maximum

PT8101

Heavy Industrial • Voltage Divider

Outline Drawing

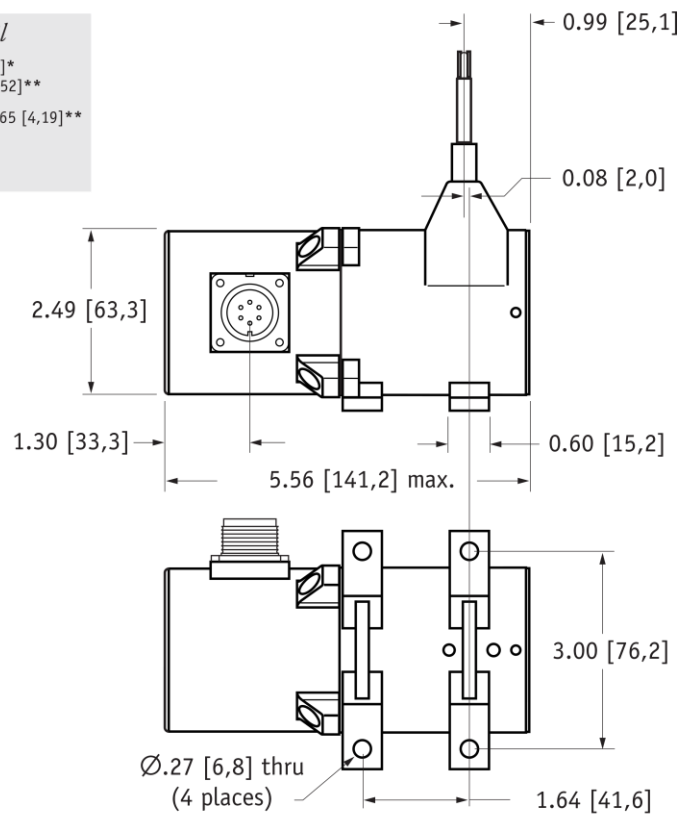
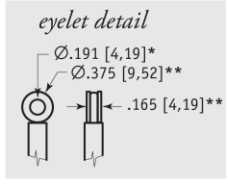
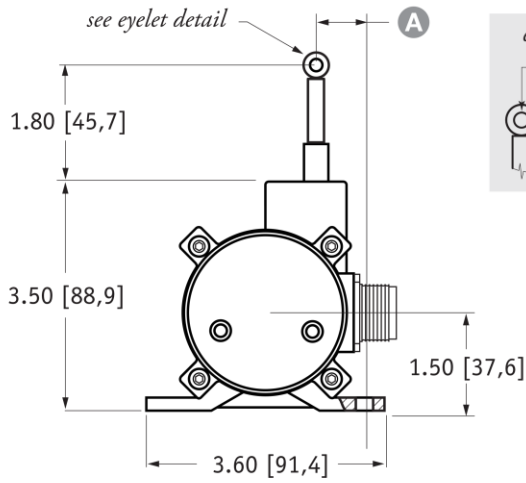

RANGE	A
2", 10"	1.16 [29,5]
5", 25", 50"	0.66 [16,8]
15"	0.99 [25,7]
20", 40"	0.85 [21,6]
30", 60"	0.52 [13,3]

DIMENSIONS ARE IN INCHES [MM]
 tolerances are ± 0.02 in. [$\pm 0,5$ mm] unless otherwise noted
 note: *tolerance = $+0.005 -0.001$ [$+0.13 -0.03$] **tolerance = $+0.005 -0.005$ [$+0.13 -0.13$]

Ordering Information

Model Number:

PT8101- _____ **1** _____ **1** _____
 order code: **R** **A** **B** **C** **D** **E** **F** **G**

Sample Model Number:

PT8101 - 0030 - 111 - 1110

- R** range: 30 inches
- A** enclosure/cable tension: aluminum/standard (13 oz.)
- B** measuring cable: .034 nylon-coated stainless
- D** output signal: 500 ohm potentiometer
- F** electrical connection: 6-pin plastic connector
- G** cable guide option: standard nylon cable guide

Full Stroke Range:

R order code:	0002	0005	0010	0015	0020	0025	0030	0040	0050	0060
full stroke range, min:	2 in.	5 in.	10 in.	15 in.	20 in.	25 in.	30 in.	40 in.	50	60
accuracy (% of f.s.)	500...10K ohm options:	1.00%	1.00%	0.15%	0.15%	0.15%	0.15%	0.10%	0.10%	0.10%
	bridge circuit options:	0.30%	0.30%	0.20%	0.20%	0.20%	0.15%	0.15%	0.15%	0.15%
potentiometer cycle life*:	2.5×10^6	2.5×10^6	5×10^5	5×10^5	5×10^5	5×10^5	5×10^5	2.5×10^5	2.5×10^5	2.5×10^5

*-1 cycle is defined as the travel of the measuring cable from full retraction to full extension and back to full retraction

Enclosure Material and Measuring Cable Tension:

A order code:	1	5	2	3	6	4	8	7	9		
enclosure:	aluminum			303 stainless			316 stainless				
cable tension:	standard	medium	high	standard	medium	high	standard	medium	high		
max. acceleration:	15 g	25 g	40 g	6 g	12 g	18 g	6 g	12 g	18 g		
cable tension option specifications	Range:	2 in.	5 in.	10 in.	15 in.	20 in.	25 in.	30 in.	40 in.	50 in.	60 in.
	Standard:	39 oz.	16 oz.	39 oz.	26 oz.	20 oz.	16 oz.	13 oz.	20 oz.	16 oz.	13 oz.
	Medium:	65 oz.	26 oz.	65 oz.	43 oz.	33 oz.	26 oz.	22 oz.	33 oz.	26 oz.	22 oz.
	High:	116 oz.	47 oz.	116 oz.	77 oz.	60 oz.	47 oz.	40 oz.	60 oz.	47 oz.	40 oz.

tension tolerance: ± 50%

Measuring Cable:

B order code:	1	2	3	4
cable construction:	∅.034-inch nylon-coated stainless steel rope	∅.047-inch bare stainless steel rope	∅.058-inch PVC jacketed vectra fiber rope	∅.031-inch bare stainless steel rope
available ranges:	all ranges	5, 15, 20, 25, 30-inch only	thru 30 inches only	40, 50, 60-inch only
general use:	indoor	outdoor, debris, high temperature	high voltage or magnetic field	outdoor, debris, high temperature

Output Signal:

D order code:	1	2	3	4	5	6
	500 ohm*	1000 ohm*	5000 ohm*	10,000 ohm*	fixed bridge (2 mV/V)	adjustable bridge (0...30 mV/V)

*tolerance = ± 10%

max. input voltage and power rating, options: 1 – 4

	2-inch, 5-inch range	10-inch to 60-inch range
500-ohms:	20 V AC/DC (1 W)	30 V AC/DC (2 W)
1K to 10K-ohms:	30 V AC/DC (1 W)	30 V AC/DC (2 W)

circuit, options 1-4

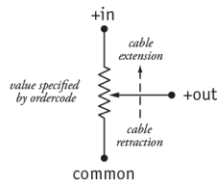

fixed bridge circuit

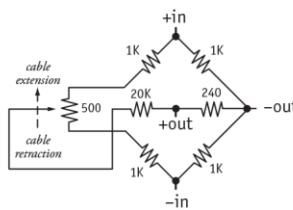

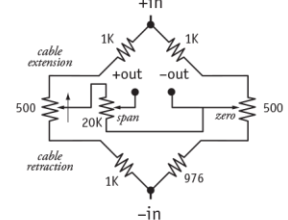

full scale output: 2 mV/V
zero adjust: not available

adjustable bridge circuit

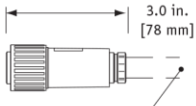
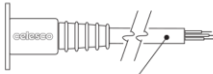
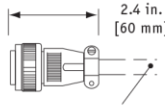

full scale output: adjustable from 0 to 30mV/V
zero adjust: to 50% of full stroke

Electrical Connection:

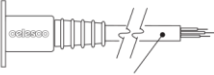
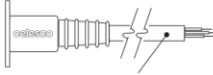
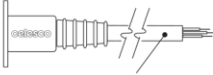
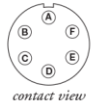
<p>F <i>order code:</i> 1</p> <p>6-pin plastic connector w/mating plug IP 67, NEMA 4X**, 6</p>  <p>3.0 in. [78 mm]</p> <p>1/2 - 5/16" [14 - 8 mm] cable dia. 16 AWG max conductor size connector: MS3102E-14S-6P mating plug: MS3106E-14S-6S</p>	<p>2</p> <p>10-ft. [3 M] waterproof cable IP 67, NEMA 4X**, 6</p>  <p>10 ft. x 0.4-in. dia. [3 M x 10 mm dia.] 3-conductor, 18 AWG type SJTOW</p>	<p>3</p> <p>6-pin metal connector w/mating plug IP 65, NEMA 4</p>  <p>2.4 in. [60 mm]</p> <p>3/8-in. [9 mm] max cable dia. 16 AWG max conductor size connector: MS3102E-14S-6P mating plug: MS3106E-14S-6S</p>	<p>4</p> <p>25-ft. [7.5 M] instrumentation cable IP 67, NEMA 6</p>  <p>25 ft. x 0.2-in. dia. [7.5 M x 5 mm dia.] 6-conductor, 24 AWG shielded</p>																																																
<p>F <i>order code:</i> 5</p> <p>100-ft. [30 M] waterproof cable IP 67, NEMA 4X**, 6</p>  <p>100 ft. x 0.4-in. dia. [30 M x 10 mm dia.] 3-conductor, 18 AWG type SJTOW</p>	<p>6</p> <p>10-ft. [3 M] pressure tested* waterproof cable IP 68, NEMA 4X**, 6P</p>  <p>10 ft. x 0.4-in. dia. [3 M x 10 mm dia.] 3-conductor, 18 AWG type SJTOW</p>	<p>7</p> <p>100-ft. [30 M] pressure tested* waterproof cable IP 68, NEMA 4X**, 6P</p>  <p>100 ft. x 0.4-in. dia. [30 M x 10 mm dia.] 3-conductor, 18 AWG type SJTOW</p>																																																	
<p>6-pin Mating Plug</p> <table border="1"> <thead> <tr> <th>pin</th> <th>standard</th> <th>bridge</th> </tr> </thead> <tbody> <tr> <td>A</td> <td>+ in</td> <td>+ in</td> </tr> <tr> <td>B</td> <td>common</td> <td>- in</td> </tr> <tr> <td>C</td> <td>+ out</td> <td>- out</td> </tr> <tr> <td>D</td> <td>-</td> <td>+ out</td> </tr> </tbody> </table>  <p>contact view</p>		pin	standard	bridge	A	+ in	+ in	B	common	- in	C	+ out	- out	D	-	+ out	<p>Waterproof Cable</p> <table border="1"> <thead> <tr> <th>color code</th> <th>standard</th> <th>bridge</th> </tr> </thead> <tbody> <tr> <td>WHITE</td> <td>+ in</td> <td>n/a</td> </tr> <tr> <td>BLACK</td> <td>common</td> <td>n/a</td> </tr> <tr> <td>GREEN</td> <td>+ out</td> <td>n/a</td> </tr> </tbody> </table> <p>Instrumentation Cable</p> <table border="1"> <thead> <tr> <th>color code</th> <th>standard</th> <th>bridge</th> </tr> </thead> <tbody> <tr> <td>RED</td> <td>+ in</td> <td>+ in</td> </tr> <tr> <td>BLACK</td> <td>common</td> <td>- in</td> </tr> <tr> <td>GREEN</td> <td>+ out</td> <td>+ out</td> </tr> <tr> <td>WHITE</td> <td>-</td> <td>- out</td> </tr> <tr> <td>BLUE</td> <td>-</td> <td>-</td> </tr> <tr> <td>BROWN</td> <td>-</td> <td>-</td> </tr> </tbody> </table>		color code	standard	bridge	WHITE	+ in	n/a	BLACK	common	n/a	GREEN	+ out	n/a	color code	standard	bridge	RED	+ in	+ in	BLACK	common	- in	GREEN	+ out	+ out	WHITE	-	- out	BLUE	-	-	BROWN	-	-
pin	standard	bridge																																																	
A	+ in	+ in																																																	
B	common	- in																																																	
C	+ out	- out																																																	
D	-	+ out																																																	
color code	standard	bridge																																																	
WHITE	+ in	n/a																																																	
BLACK	common	n/a																																																	
GREEN	+ out	n/a																																																	
color code	standard	bridge																																																	
RED	+ in	+ in																																																	
BLACK	common	- in																																																	
GREEN	+ out	+ out																																																	
WHITE	-	- out																																																	
BLUE	-	-																																																	
BROWN	-	-																																																	

*-Test pressure: 100 feet [30 meters] H₂O (40 PSID); Test Medium: Air; Duration: 2 hours. **-Applies to stainless steel enclosure only.

Cable Guide Options:

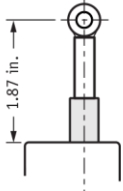
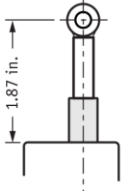
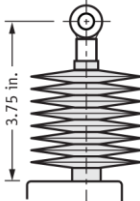
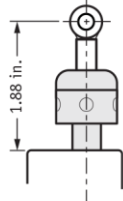
<p>G <i>order code:</i> 0</p> <p>standard cable guide</p>  <p>1.87 in.</p>	<p>1</p> <p>stainless steel cable guide</p>  <p>1.87 in.</p>	<p>2*</p> <p>polyurethane cable bellows</p>  <p>3.75 in.</p>	<p>3</p> <p>integral cable brush</p>  <p>1.88 in.</p>
---	--	---	---

*note: all ranges up to 25 inches only

PT8101

Heavy Industrial • Voltage Divider

VLS Option - Free Release Protection

The patented Celesco Velocity Limiting System (VLS) is an option for PT8000 Series cable extension transducers that limits cable retraction to a safe 40 to 55 inches per second.

The VLS option prevents the measuring cable from ever reaching a damaging velocity during an accidental free release. This option is ideal for mobile applications that require frequent cable disconnection and reconnection. It prevents expensive unscheduled downtime due to accidental cable mishandling or attachment failure.

VLS is NOT available for medium and high cable tension options, steel enclosure, cable bellows or 2, 5 and 15-inch stroke ranges.

How to Configure Model Number for VLS Option:

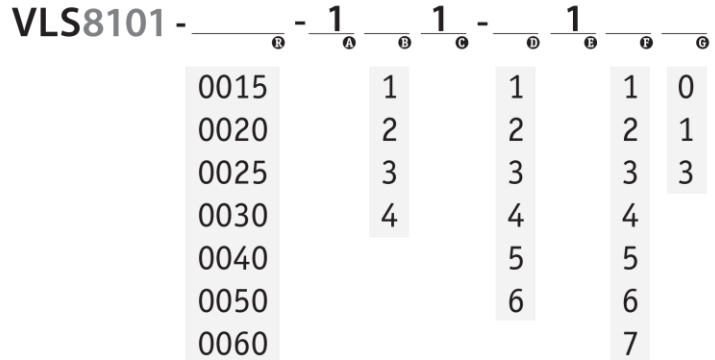

☐ = available options**

creating VLS model number (example):

1. select PT8101 model **PT8101-0060-111-1110**
2. remove "PT" from the model number ~~PT~~ **8101-0060-111-1110**
3. add "VLS" **VLS + 8101-0060-111-1110**
4. completed model number ! **VLS8101-0060-111-1110**

**Note: please contact factory for a solution to options not supported.



19 Waterman Ave. Toronto, Ont. M4B1Y2
Tel: 416-445-5500 Fax: 416-445-1170
Toll Free: 1-800-465-1600
Email: sales@intertechnology.com
Website: www.intertechnology.com

TE.com/sensorsolutions

Measurement Specialties, Inc., a TE Connectivity company.

Measurement Specialties, TE Connectivity, TE Connectivity (logo) and EVERY CONNECTION COUNTS are trademarks. All other logos, products and/or company names referred to herein might be trademarks of their respective owners.

The information given herein, including drawings, illustrations and schematics which are intended for illustration purposes only, is believed to be reliable. However, TE Connectivity makes no warranties as to its accuracy or completeness and disclaims any liability in connection with its use. TE Connectivity's obligations shall only be as set forth in TE Connectivity's Standard Terms and Conditions of Sale for this product and in no case will TE Connectivity be liable for any incidental, indirect or consequential damages arising out of the sale, resale, use or misuse of the product. Users of TE Connectivity products should make their own evaluation to determine the suitability of each such product for the specific application.

© 2015 TE Connectivity Ltd. family of companies All Rights Reserved.

PT8101 12/01/2015