

## PT5600

### Cable Actuated Sensor Industrial Grade • Cable Reel

**Absolute Linear Position to 250 inches (6350 mm)**

**Hard Anodized Aluminum Enclosure**

**Converts Virtually Any Encoder to a Linear Position Sensor**

**Available With or Without Encoder**

#### General

|                                |  |
|--------------------------------|--|
| <b>Full Stroke Range</b>       | 0-50 to 0-250 inches   |
| <b>Motion Conversion Ratio</b> | 8 inches per turn,<br>see ordering information                   |
| <b>Accuracy</b>                | the lesser of 0.02% full stroke or 0.04%<br>of measurement range |
| <b>Measuring Cable</b>         | stainless steel or thermoplastic                                 |
| <b>Module Material</b>         | hard anodized aluminum   |
| <b>Weight</b>                  | 5 lbs., max  |

#### Environmental

|                              |                                 |
|------------------------------|---------------------------------|
| <b>Operating Temperature</b> | -40° to 200°F<br>(-40° to 90°C) |
|------------------------------|---------------------------------|

Our unique linear-to-rotational, industrial-grade string encoder module mates to virtually any encoder, giving you a cost-effective linear position measurement solution that precisely fits your requirements. The PT5600 takes just minutes to install, fits easily into tight areas, does not require perfectly parallel alignment, and provides reliable and precise position measurements without needing periodic adjustments.

For any high resolution or absolute encoder requirement, the PT5600 delivers the ultimate in flexibility. To order, simply select the measurement range and encoder mounting style—it's that easy! We even supply all the necessary encoder mounting tools and attaching hardware. If you can't find your encoder mounting style or you want us to provide the encoder, please give us a call.

# PT5600

Industrial Grade • String Encoder

## Outline Drawing

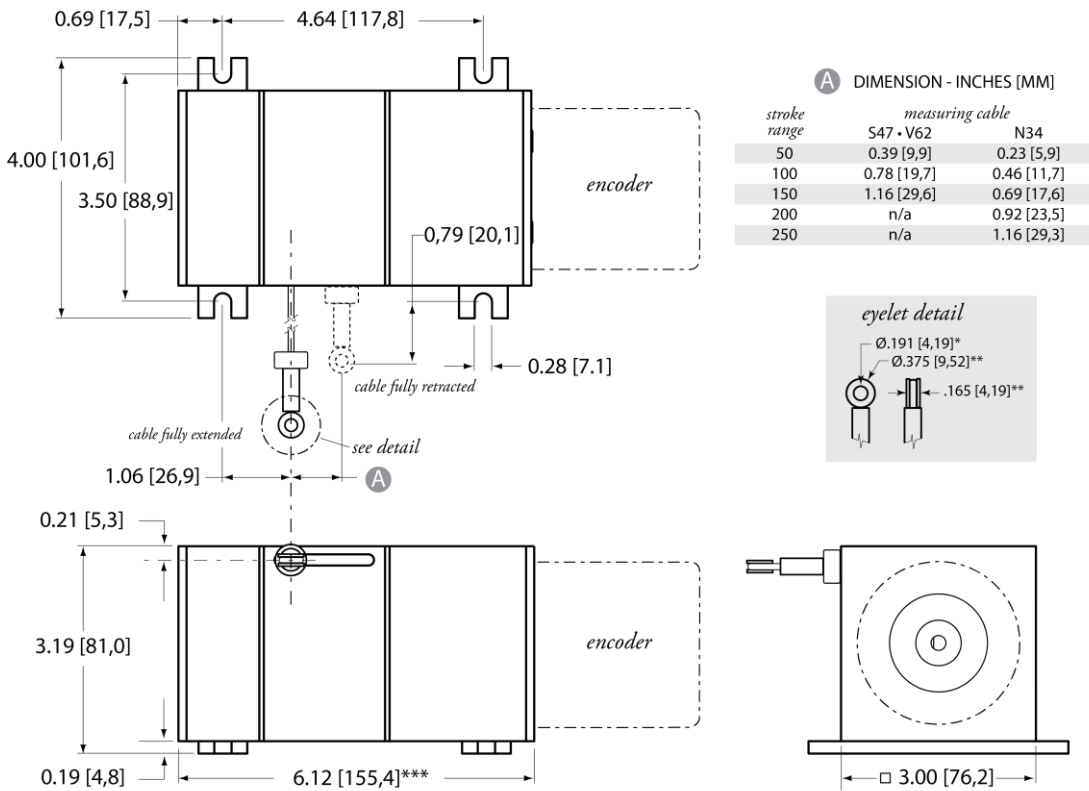

DIMENSIONS ARE IN INCHES [MM]  
 tolerances are  $\pm 0.02$  in. [ $\pm 0.5$  mm] unless otherwise noted  
 note: \*tolerance =  $+0.005 -0.001$  [ $+0.13 -0.03$ ] \*\*tolerance =  $+0.005 -0.005$  [ $+0.13 -0.13$ ] \*\*\*Overall dimension may vary depending on encoder configuration

## Ordering Information

### Model Number:

**PT5600** - \_\_\_\_\_  
 order code:                    **R**                    **A**                    **B**                    **C**

Sample Model Number:

**PT5600 - 100 - N34 - FR - F01**

- R** range: 100 inches
- A** measuring cable: .034 nylon-coated stainless
- B** cable exit: front
- C** rotational sensor mounting style: F01 (2.5-in. sq. flange)

» Trying to reorder but can't find your existing model number? Please contact factory for help.

### Full Stroke Range:

| <b>R</b> order code:          | 50        | 100       | 150       | 200       | 250       |
|-------------------------------|-----------|-----------|-----------|-----------|-----------|
| full stroke range, min:       | 50 in.    | 100 in.   | 150 in.   | 200 in.   | 250 in.   |
| cable tension ( $\pm 20\%$ ): | 41 ounces | 41 ounces | 41 ounces | 21 ounces | 21 ounces |

### Measuring Cable:

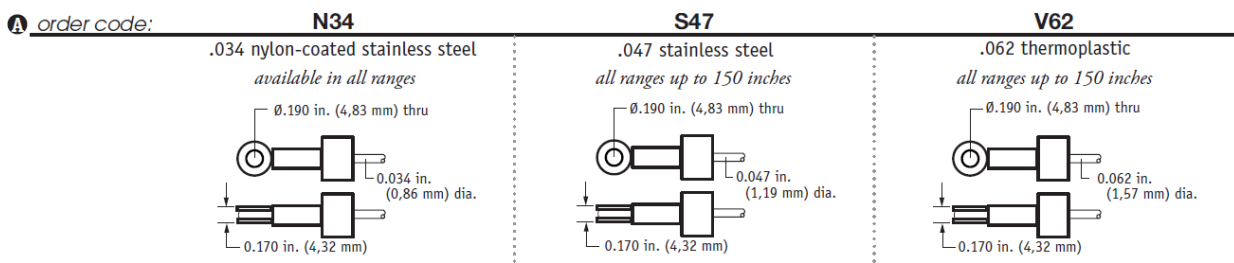

**PT5600**

Industrial Grade • String Encoder

**Cable Exit:**

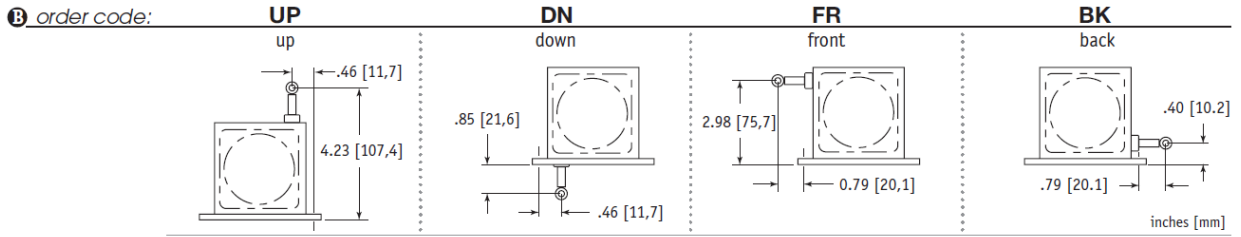

**Rotational Sensor Mounting Style:**

**C** order code:

| F01                                    | F02                                  | S01  | S02   | S04   |
|--|--------------------------------------|--|---|---|
| 2.5-in. Flange Mount<br>3/8-inch shaft | 2-in. Flange Mount<br>3/8-inch shaft | Face-Mount<br>6 mm shaft<br>M4 mounting screws | Face-Mount<br>10 mm shaft<br>M4 mounting screws | Face-Mount<br>10 mm shaft<br>M3 mounting screws |

*Note: If you don't see your encoder style, please contact factory. All encoder types supported.*

**F01 - 2½-inch Sq. Flange Mount (3/8-inch shaft)**

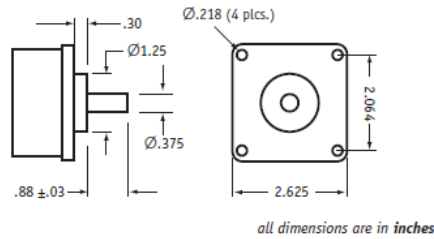

**F02 - 2-inch Sq. Flange Mount (3/8-inch shaft)**

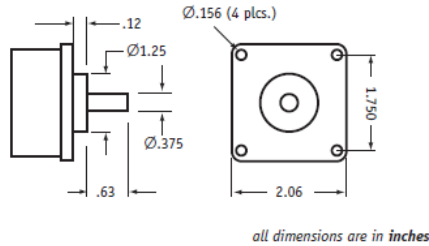

**S01 - Face-Mount (6mm shaft/M4 screws)**

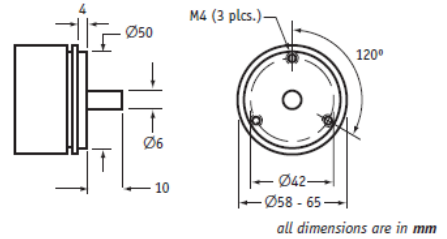

**S02 - Face-Mount (10mm shaft/M4 screws)**

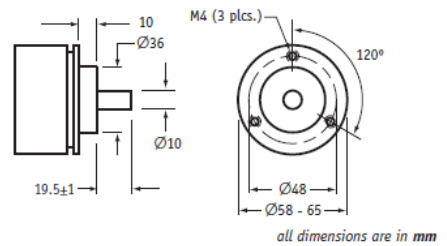

**S04 - Face-Mount (10mm shaft/M3 screws)**

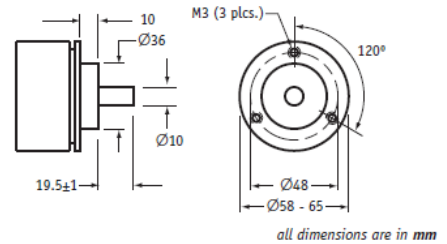

**19 Waterman Ave. Toronto, Ont. M4B1Y2**  
**Tel: 416-445-5500 Fax: 416-445-1170**  
**Toll Free: 1-800-465-1600**  
**Email: sales@intertechnology.com**  
**Website: www.intertechnology.com**

Terms and Conditions of Sale for this product and in no case will TE Connectivity be liable for any incidental, indirect or consequential damages arising out of the sale, resale, use or misuse of the product. Users of TE Connectivity products should make their own evaluation to determine the suitability of each such product for the specific application.

© 2015 TE Connectivity Ltd. family of companies All Rights Reserved.

PT5600 12/01/2015